

The Open Group OGA-032

The Open Group ArchiMate 3 Part 2 Exam

For More Information – Visit link below:

<https://www.examsempire.com/>

Product Version

1. Up to Date products, reliable and verified.
2. Questions and Answers in PDF Format.

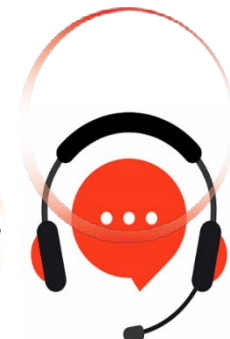

<https://examsempire.com/>

Visit us at: <https://www.examsempire.com/oga-032>

Latest Version: 6.1

Question: 1

Please read this scenario prior to answering the question

The IT Operations (IT Ops) department at ArchiSurance has five core responsibilities, each encompassing a dedicated business process: (1) Batch Operations (Batch Ops), (2) Online Operations (Online Ops), (3) Security Operations (Security Ops), (4) User Support and (5) Continuous Improvement. Service level agreements (SLAs) are in place for Batch Ops and Online Ops, and each Ops process generates monitoring data that is utilized by the Continuous Improvement process.

The System Ops category consists of Batch Ops, Online Ops, and Security Ops, each having an incident management sub-process. These sub-processes are triggered by Batch, Online, and Security Incidents, respectively. In the initial stages of

the incident management sub-processes, an Incident Alert is shared with the other System Ops processes by posting it to the Alert Buffer.

Batch Ops relies on a schedule that outlines all batch jobs and their dependencies. This schedule serves two sub-processes: Batch Planning, which updates the schedule for use by the Execution Management sub-process.

The Batch Ops process relies on a suite of interconnected applications to facilitate its operations. Among these applications, the Batch Scheduler plays a vital role by allowing users to manage a comprehensive database of jobs, job schedules, and

dependencies. It effectively launches batch jobs according to the information stored in the database.

Working in conjunction with the Batch Scheduler, the Batch Monitor application utilizes the job schedules as a reference point to monitor job execution. It identifies any exceptional conditions that may arise during the execution process. To ensure

effective handling of these exceptions, the Batch Monitor communicates the information to both the Batch Scheduler and the Incident Handler applications through the previously mentioned Alert Buffer.

The Incident Handler application operates based on a defined set of business rules. It uses these rules to determine the relevant systems and individuals that need to be notified in the event of each incident.

Subsequently, the Incident Handler

application generates appropriate notifications according to these determinations.

Recognizing the criticality of the Batch Scheduler, Batch Monitor, and Incident Handler applications, ArchiSurance has implemented redundant hosting arrangements across multiple geographically distributed data centers. In each data center,

these three applications are supported by fully redundant virtual server clusters. Each cluster is connected to two site local area networks, both of which are further linked to separate storage array hardware devices.

Refer to the scenario

As part of an IT service management initiative, you have been assigned the task to show how applications and technology support the Batch Ops process. This should show the relationships between the applications, their functions, the data

they access, and the technology that hosts the applications and data, along with the networks that connect the servers. It is only necessary to model a single data center.

Which of the following answers provides the most complete and accurate model?

A.

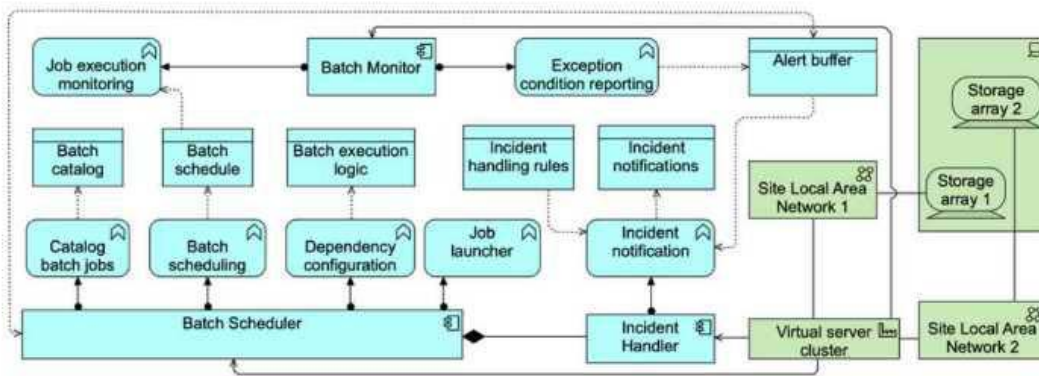

B.

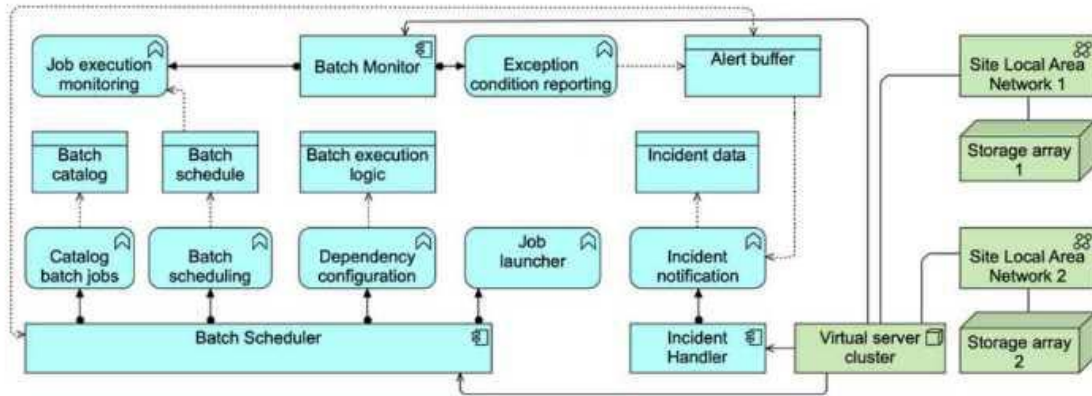

C.

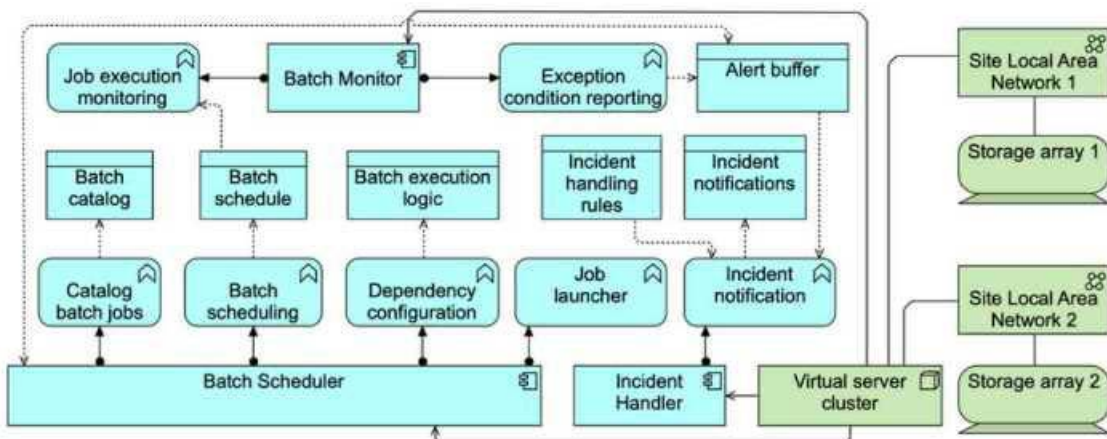

D.

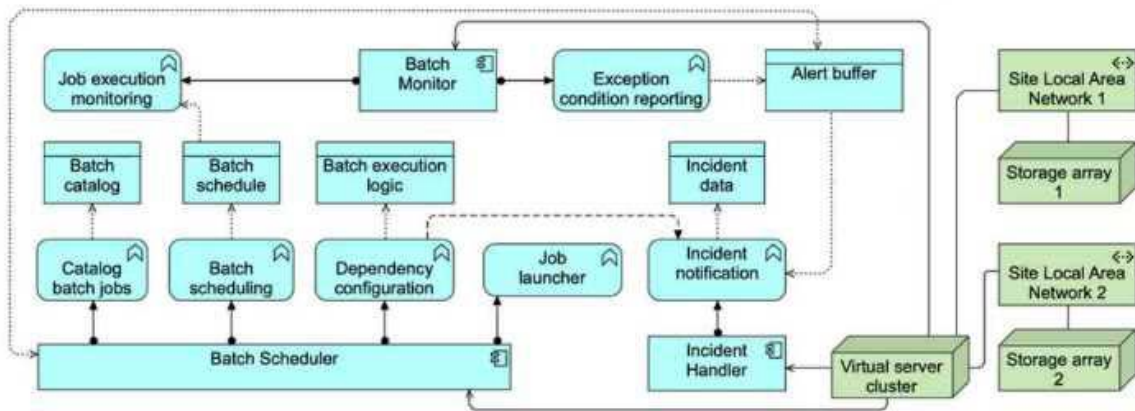

- A. Option A
- B. Option B
- C. Option C
- D. Option D
- E. Option E

Answer: C

Explanation:

The correct answer is C as it provides the most complete and accurate model according to the ArchiMate® 3 framework and the given scenario.

Here's why:

Business Processes and Sub-Processes:

Batch Operations (Batch Ops) is one of the core responsibilities in IT Operations, and its processes are modeled clearly. The Batch Scheduler is responsible for managing batch jobs, schedules, and dependencies.

The Batch Monitor is correctly shown to monitor the job execution and notify exceptions using the Alert Buffer.

The Incident Handler is used to notify relevant systems and individuals, triggered by the incident detection from Batch Monitor. This is modeled by the use of incident handling rules and notifications.

Application Layer (Application Components and Functions):

The Batch Scheduler, Batch Monitor, and Incident Handler are accurately depicted as the main applications. These applications are crucial for managing job scheduling, monitoring execution, and handling incidents.

These applications share the same virtual server cluster, which is an important detail reflecting redundancy and high availability, which was mentioned in the scenario.

The interrelationships between applications are accurately depicted: the Batch Scheduler launches jobs, the Batch Monitor checks their status, and Incident Handler deals with exceptions.

Data Access:

The Batch Scheduler accesses and updates batch jobs and schedules, and this is represented clearly.

The Incident data and Incident notifications are accurately modeled as being used by Incident Handler.

Technology Layer:

The Virtual server cluster, Storage arrays, and Site Local Area Networks are appropriately connected to

support the application infrastructure.

Redundancy is shown through the use of multiple storage arrays and network connections, as described in the scenario.

Accuracy in Relationship Types (ArchiMate® 3) Reference:

The relationships between components are modeled using ArchiMate® 3 standards, such as flow relationships between the Batch Monitor and Alert Buffer or between the Incident Handler and storage components.

Triggering relationships exist between the applications that manage batch jobs and the monitoring/notification process, ensuring correct job execution and incident handling.

Conclusion: Answer C is the most complete model, as it accurately reflects the roles of the various applications, their interactions, and the underlying technology components in support of the Batch Ops process, following the guidelines and modeling standards of ArchiMate® 3.

Question: 2

Please read this scenario prior to answering the question

The ArchiSurance senior management, board members, customers, and major stockholders have expressed long-standing concerns regarding the business continuity risks associated with relying on a single data center. Located in an area prone to flooding, earthquakes, and occasional water leaks from the cafeteria above, the current data center has significant vulnerabilities.

To address these concerns and mitigate the risks, ArchiSurance has developed a comprehensive plan to relocate its existing data center to two separate ready-to-use data centers in different cities. As a major undertaking, the approval of the

Board of Directors is required to proceed with the project.

The primary objectives of the data center move are to reduce the risk of business interruptions, reduce both planned and unplanned downtime for critical applications, and provide reassurance to

ArchiSurance stakeholders. Ensuring minimal

disruption during the transition is crucial. However, several constraints make the planned migration to the new data centers particularly challenging. Certain critical ArchiSurance applications cannot be offline for more than one hour, and any

planned downtime must be restricted to specific four-hour windows on weekends. Additionally, the migration cannot take place during quarterly or year-end closing periods to avoid disrupting critical processing operations.

ArchiSurance management has devised a multi-phase data center transformation program to facilitate a smooth transition. Each phase is critical for establishing stable and fully functional data center configurations throughout the transformation

process. The initial phase entails detailed scheduling and planning to develop a comprehensive transformation plan aligned with ArchiSurance's timing and scheduling requirements. During the second phase, ArchiSurance will procure the

necessary hardware and software for the new data centers, while also seeking refunds for the hardware and software in the current data center once it is decommissioned. The third phase involves setting up the new data centers and conducting

parallel testing of the new hardware and software alongside the existing production environment. The transition between the old and new data centers occurs in the fourth phase, followed by the fifth phase, which is the decommissioning of the old

data center. This involves returning the hardware and software to obtain the contracted refunds. Each phase, from the second to the fifth, is initiated once specific conditions outlined in the previous phase have been met.

Refer to the Scenario

The program manager overseeing the data center transformation has asked you to model an outline of the implementation plan which has three stable states defined. You should show the deliverables associated with each plateau in connection with the physical elements. Additionally, you need to show how each phase contributes to achieving a stable state for the data center transformation.

Which of the following answers provides the best description?

A.

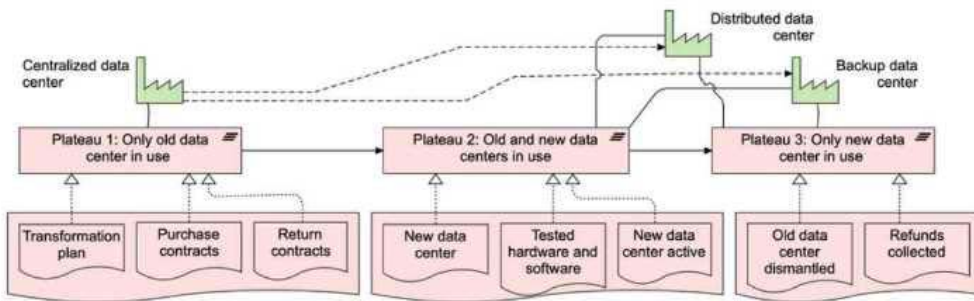

B.

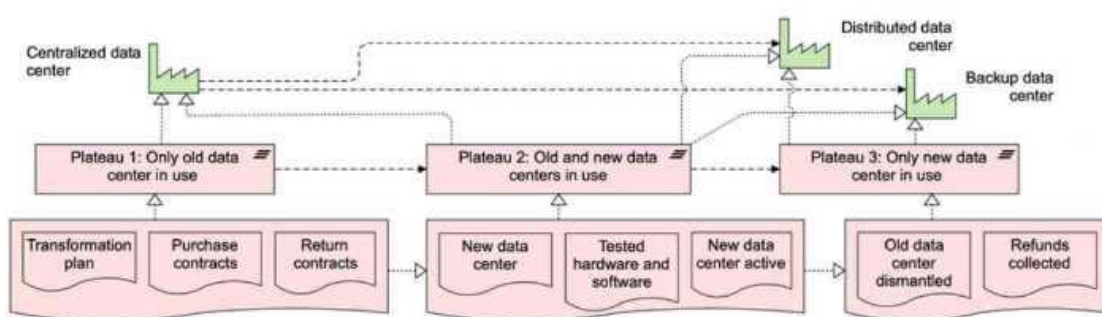

C.

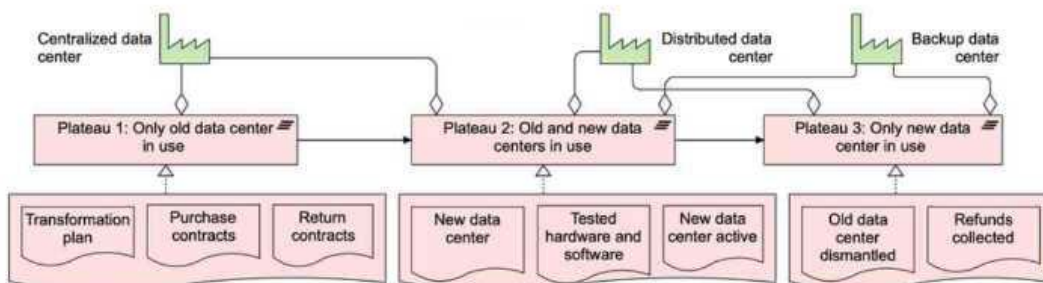

D.

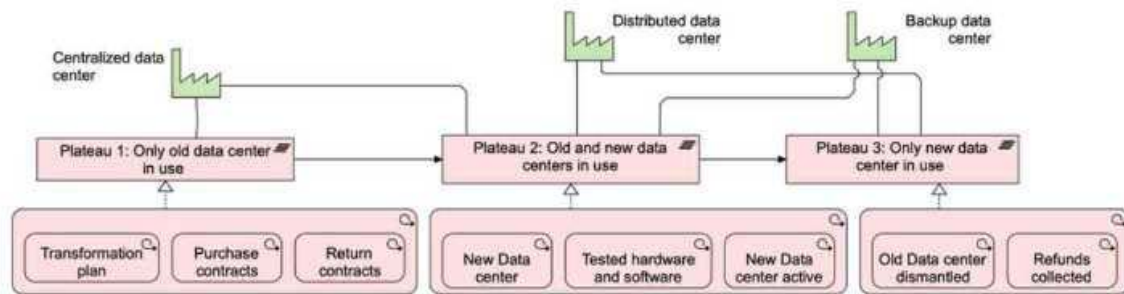

- A. Option A
- B. Option B
- C. Option C
- D. Option D
- E. Option E

Answer: A

Explanation:

This question focuses on modeling the implementation plan for the data center transformation at ArchiSurance. The goal is to represent how the different phases of the project contribute to achieving the three stable states, or plateaus, while illustrating the deliverables connected to these plateaus and the physical elements involved.

Key ArchiMate® 3.2 Concepts Applied:

Plateaus:

Plateaus represent intermediate stable states within an architecture transformation, showing the condition of the architecture at specific moments in time. In this scenario, the plateaus correspond to the stable data center configurations at different phases:

Plateau 1: Only the old data center is in use.

Plateau 2: Both the old and new data centers are in use simultaneously.

Plateau 3: Only the new data center is in use, and the old data center is fully decommissioned.

Physical Elements:

These refer to the data centers, hardware, software, and networks that make up the infrastructure being migrated. These should be clearly depicted in connection with each phase of the transformation program.

Deliverables and Phases:

Each phase of the transformation process includes specific deliverables, such as:

Procurement of new hardware and software.

Setting up and testing the new data centers.

Transitioning between the old and new data centers.

Dismantling the old data center and returning its hardware for refunds.

Work Packages and Dependencies:

Work packages represent activities or tasks in ArchiMate® and are connected to the plateaus. These must be modeled with proper sequencing, showing how each phase contributes to reaching the next stable state.

Why Option A is Correct:

Option A accurately represents the three plateaus (stable states) and clearly illustrates the deliverables

(e.g., the new data center, tested hardware and software, and dismantled old data center) in relation to each phase of the transformation.

The connections between the physical elements (such as the centralized data center, distributed data center, and backup data center) are properly displayed and aligned with the described multi-phase process.

The phases are laid out logically, showing how each phase (e.g., procurement, testing, transition) leads to the next stable state (plateau), following the principles of a plateau and work package transformation in ArchiMate®.

The flow of deliverables from one plateau to the next is consistent with the need for dependencies (e.g., the new data center cannot be fully active until the hardware and software have been tested in parallel).

Why Other Options Are Incorrect:

Option B and Option D do not show the relationships between the phases and the stable states as clearly as Option A. They lack some critical connections or do not accurately represent the progression between plateaus and the physical infrastructure.

Option C is closer but misses important sequencing in how the work packages (activities) and plateaus interact, leading to an incomplete representation of the transformation.

Conclusion:

Option A provides the most complete and accurate description based on ArchiMate® 3.2 modeling principles. It correctly demonstrates how each phase of the data center transformation contributes to achieving the stable states (plateaus) and ensures that the physical elements, work packages, and deliverables are properly aligned.

Question: 3

Please read this scenario prior to answering the question

The ArchiSurance Mobile consumer solution is used for selling and renewing insurance products, providing customer service, enabling accurate and convenient home recordkeeping, and capturing and processing claims. The solution consists of three applications. The Consultant application lets customers review their existing coverage, and update it based on common life events, such as getting a new car, moving into a new home, or having a family member move in or out. If necessary, they can speak or chat with a customer service representative. The Home Manager application helps customers photograph and catalogue their valuable possessions in order to support the filing of accurate claims in case of loss or damage. The

Claim Manager application enables customers to quickly file a claim for loss or damage to an insured auto, home or possession. It enables customers to describe the incident by referencing information captured with the Consultant and the Home

Manager applications. In addition, it allows the customer to add photographs, audio, video and text to support a claim, submit the claim, and monitor its progress.

The ArchiSurance Mobile applications rely on a number of application services hosted by ArchiSurance. The first is an Auto Identification and Description (AID) service that the Consultant application uses to validate and complete auto information

entered by customers. The second service, Home Identification and Description (HID) performs the same function for home information, and is used by the Home Manager application. The Consultant application also uses the Virtual Agent

service to guide customers as they select coverage options, the Payment Processor service to arrange premium payments, and the Coverage Activator service to generate policies and put them in force.

ArchiSurance Mobile also relies on a number of technology services. The Home Manager application uses a Multimedia Repository service to store and retrieve information about insured homes. The Claim Manager application also uses this service for claim information entered by customers. All three ArchiSurance Mobile applications use a Personal Security service to register and authenticate customers, and to manage their profiles. Each application service is realized by an application component with the same name. Each technology service is realized by a system software environment, having the same name. ArchiSurance hosts both the application components and system software environments in a virtualized server pool within its data center. Each service has its own virtual server. Each virtual server is connected to a data center network (DCN) which in turn connects to a commercial wide area network (WAN).

Refer to the Scenario

You have been asked to show the applications that make up the ArchiSurance Mobile solution and the technology that supports these applications.

Which of the following answers provides the best description? Note that it is not necessary to model the networks.

A.

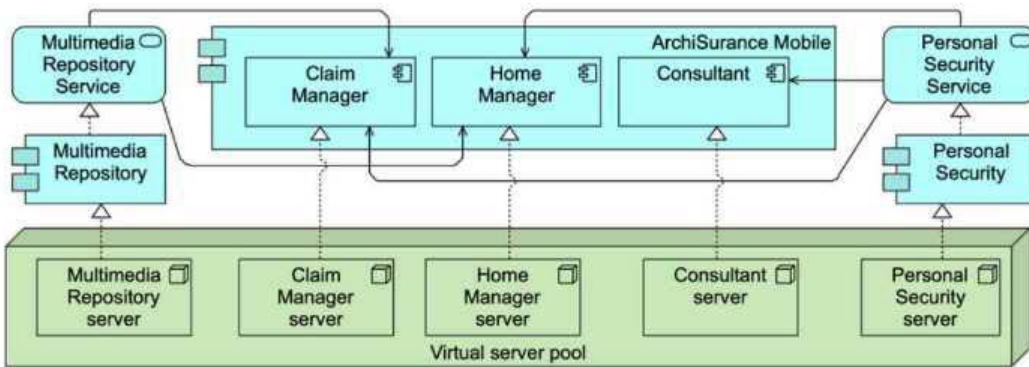

B.

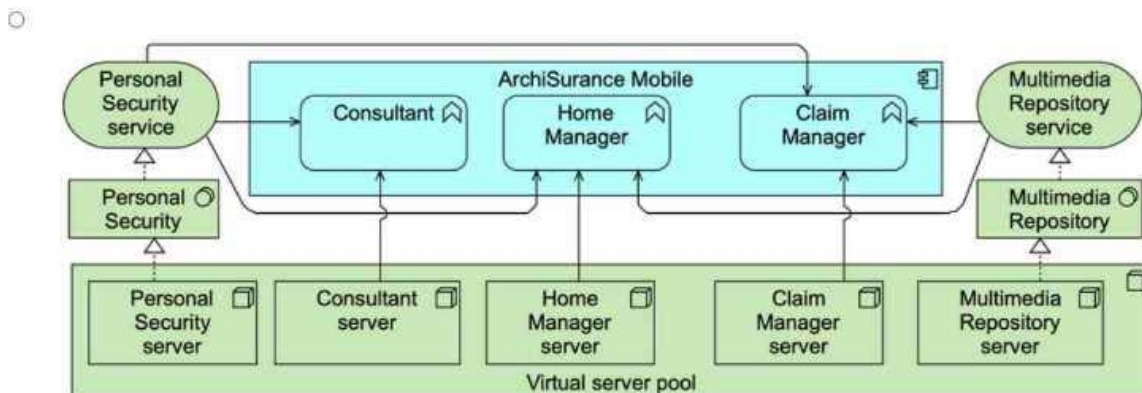

C.

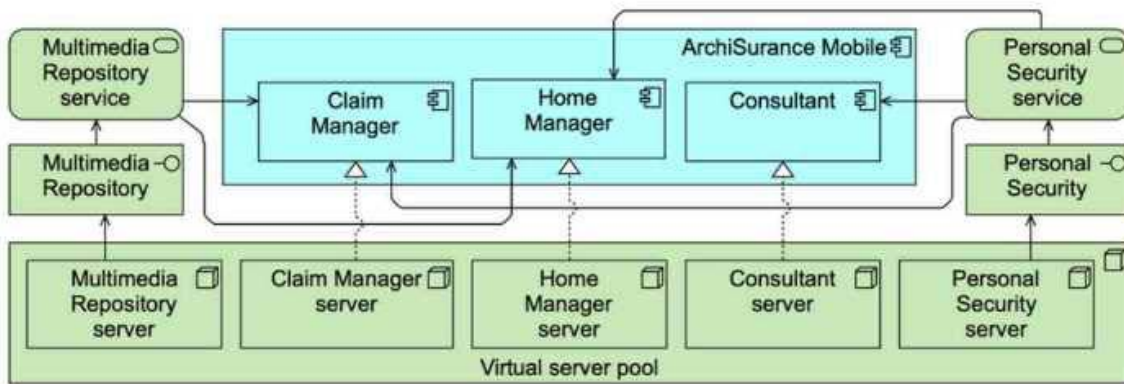

D.

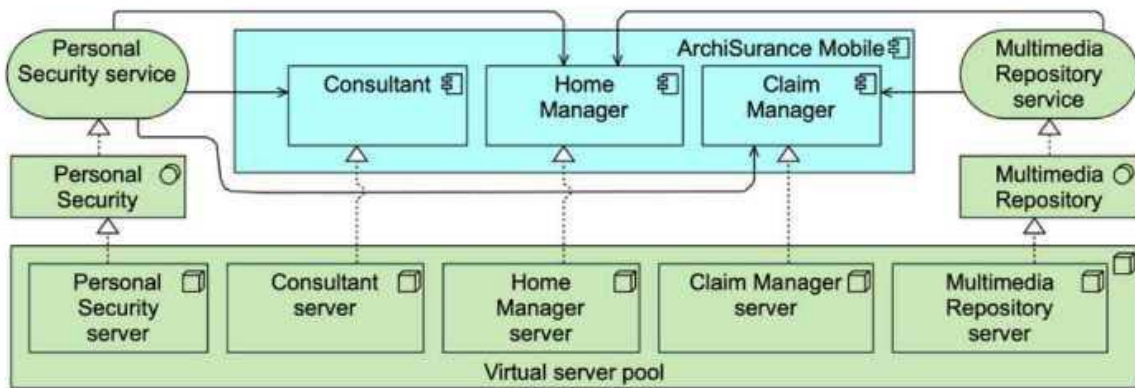

- A. Option A
- B. Option B
- C. Option C
- D. Option D
- E. Option E

Answer: C

Explanation:

In this scenario, the focus is on modeling the ArchiSurance Mobile solution, showing the applications that make up this solution and the technology infrastructure that supports them. This includes applications, application services, and the system software environments (technology services) upon which the applications rely.

Key ArchiMate® 3.2 Concepts Applied:

Application Components and Services:

Consultant Application: This allows customers to review, update coverage, and speak with customer service representatives. It uses the following application services:

Auto Identification and Description (AID) for validating auto information.

Virtual Agent for helping customers select options.

Payment Processor to arrange payments.

Coverage Activator to generate and activate policies.

Home Manager Application: This allows customers to catalogue possessions and use the Home Identification and Description (HID) service to validate home information.

Claim Manager Application: Enables filing of claims, referencing data from the Consultant and Home Manager applications and storing information (such as photos, videos) via the Multimedia Repository.

Technology Services:

Personal Security Service: Used for customer registration, authentication, and profile management across all three applications.

Multimedia Repository Service: Used to store and retrieve information related to home possessions and claim details, supporting both the Home Manager and Claim Manager applications.

Technology Infrastructure:

Each application component (Consultant, Home Manager, Claim Manager) is hosted on its own virtual server within a virtualized server pool.

Each technology service is realized by a corresponding system software environment (e.g., Multimedia Repository, Personal Security), each with its own virtual server.

The infrastructure is hosted in a data center, but the focus here is on the services rather than the network connections.

Why Option C is Correct:

Option C accurately represents the key applications (Consultant, Home Manager, Claim Manager) in connection with the appropriate technology services and their respective virtual servers.

The model shows the relationships between the applications and their dependencies on Personal Security and Multimedia Repository, aligning with the description provided.

The virtual server pool is depicted clearly, showing how the applications and services are realized within this infrastructure.

The relationships between applications and application services (AID, HID, Virtual Agent, Payment Processor, Coverage Activator) are not modeled in full detail here, but they are implicitly understood through the applications.

Why Other Options Are Incorrect:

Option A and Option D both incorrectly depict some relationships between the applications and their supporting technology services or servers, or miss certain dependencies.

Option B does not provide as clear a depiction of the virtualized infrastructure and how the applications relate to the Multimedia Repository and Personal Security services.

Conclusion:

Option C provides the most accurate and complete description of the ArchiSurance Mobile solution and the supporting technology, as required by the scenario. It correctly illustrates the relationships between the applications, the virtual servers, and the supporting technology services according to ArchiMate® 3.2 principles.

Question: 4

Please read this scenario prior to answering the question

ArchiSurance has decided to leverage its financial expertise by offering defined contribution retirement plans. Each trading day, ArchiSurance submits consolidated mutual fund trading transactions to a stock exchange on behalf of its retirement plan participants.

The daily mutual fund trading cycle consists of four key processes: Transaction capture, pricing, trading and reconciliation. Transaction capture consists of two sub-processes: manual exchange and loans and

distributions (L&D). For transaction capture, retirement plan participants use an online account management application to enter manual fund exchange transactions. For L&D, plan participants use a separate application to enter requests. The L&D application determines whether the request can be fulfilled based on the mutual fund balances held in each plan balances and a set of business rules. Each day's captured manual exchange transactions accumulate in a transaction database. ArchiSurance contracts with a third-party information service to receive a file of mutual fund prices at the close of each trading day. The pricing application uses this file to convert captured transaction into trades, and then validates each trade against the mutual fund balances held in each plan. The pricing application generates a trade file with the minimum number of trades necessary. The trading application sends this file to an external trading service. When the trading application receives a confirmation file back from the trading service, it causes the reconciliation application to update the plan recordkeeping database. The account management and L&D applications are hosted on separate application server clusters. Each cluster is a physically separate host that runs application server software on a set of virtualized hosts. All of these applications use a database server infrastructure that is hosted on another separate cluster of virtualized servers also on a dedicated physical host. The pricing, consolidation, trading and reconciliation applications, however, are batch applications that run on the ArchiSurance mainframe computer. All application hosts are connected via a converged data center network (DCN), which also connects them to a storage area network (SAN) as well as a wide area network (WAN) that is used to communicate with the external trading service. The SAN includes two physically separate storage arrays, one of which holds data for all databases, and another that holds data for all files. Refer to the Scenario

The systems analysts would like to better understand the business processes and applications for daily fund trading. You have been asked to describe the business processes and sub-processes, the applications that they use, the data objects accessed by those applications, and the external application services that access some of those data objects.

Which of the following is the best answer? Note that you are not required to model the business actors/roles.

A.

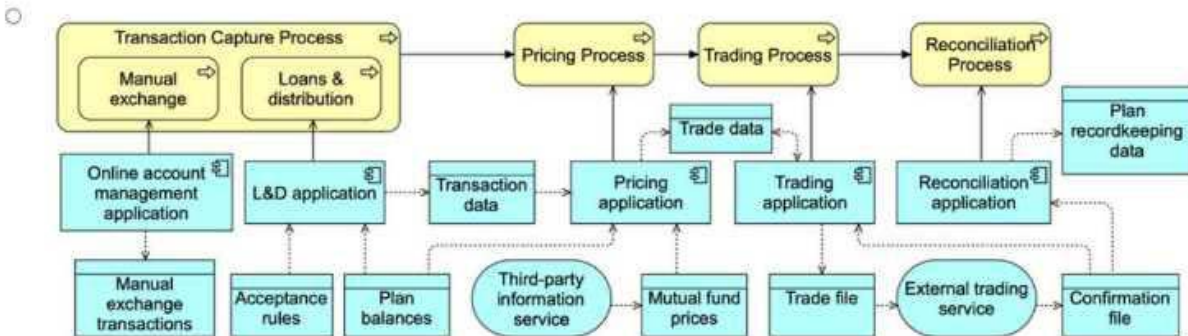

B.

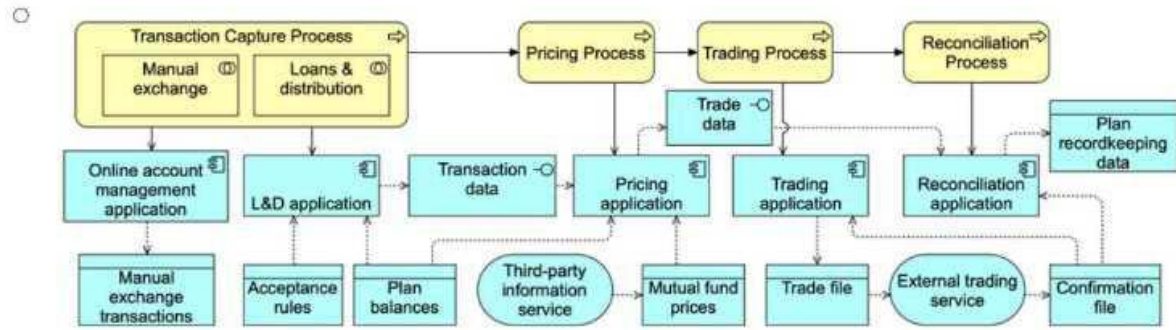

C.

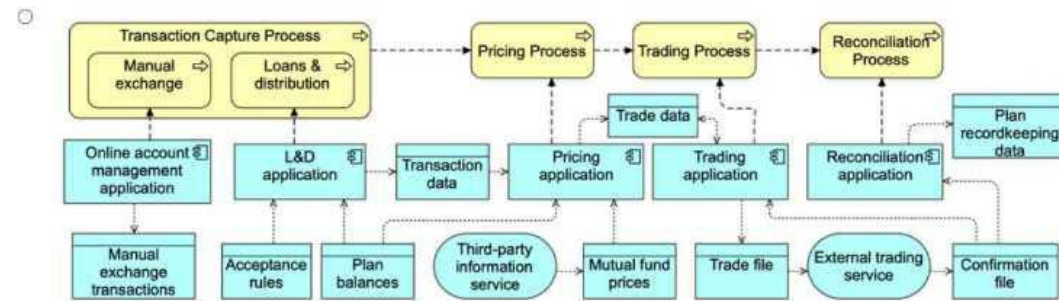

D.

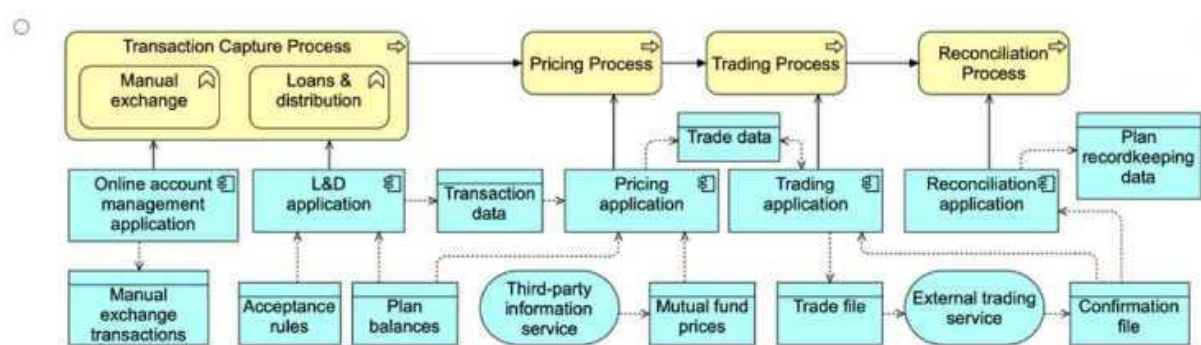

- A. Option A
- B. Option B
- C. Option C
- D. Option D
- E. Option E

Answer: B

Explanation:

In this scenario, the goal is to model the business processes, their sub-processes, the applications supporting these processes, and the data objects these applications access. Additionally, external services that access some of these data objects need to be shown. This includes capturing the key processes and their dependencies, as well as understanding how the applications interact with data and external services.

Key ArchiMate® 3.2 Concepts Applied:

Business Processes and Sub-Processes:

Transaction Capture Process: Consists of two sub-processes:

Manual Exchange

Loans & Distribution (L&D)

This process is responsible for capturing transactions from users through different applications (Online Account Management, L&D Application).

Pricing Process: This process uses the Mutual Fund Prices from a third-party service and the Plan Balances to validate and price trades.

Trading Process: This process generates a Trade File and interacts with an external Trading Service.

Reconciliation Process: This final process updates the Plan Recordkeeping Data after confirming trades from the External Trading Service.

Applications and Data:

Online Account Management Application and L&D Application: These capture user inputs for transactions and maintain Transaction Data and Plan Balances.

Pricing Application: Uses Mutual Fund Prices and Transaction Data to generate Trade Data.

Trading Application: Submits Trade Data and receives a Confirmation File from the external Trading Service.

Reconciliation Application: Uses the Confirmation File to update Plan Recordkeeping Data.

External Application Services:

Third-Party Information Service: Provides Mutual Fund Prices.

External Trading Service: Processes trades and returns a Confirmation File.

Data Objects:

Transaction Data: Captured by the transaction capture processes.

Mutual Fund Prices: Received from the third-party service.

Trade Data: Generated by the pricing and trading applications.

Plan Recordkeeping Data: Updated by the reconciliation process after trade confirmation.

Why Option B is Correct:

Option B provides the most complete and accurate representation of the scenario. It captures the business processes (Transaction Capture, Pricing, Trading, Reconciliation) and their sub-processes, while showing the appropriate connections to the applications that support these processes.

It clearly depicts the data objects (Transaction Data, Plan Balances, Trade File, Mutual Fund Prices, Plan Recordkeeping Data) and their flows between the processes and applications.

The model also includes the external services (Third-Party Information Service and External Trading Service), showing how these interact with the internal applications and data objects.

It accurately represents the flow of Trade Data from the Pricing Application to the Trading Application, and the use of Mutual Fund Prices by the Pricing Process.

Why Other Options Are Incorrect:

Option A and Option D miss some critical connections between the applications and the external services. They also lack clarity in how the data flows between the processes and applications.

Option C does not adequately represent the interaction between the applications and the external services (e.g., Third-Party Information Service), which is a key requirement in this scenario.

Conclusion:

Option B provides the best and most accurate description of the business processes, applications, data objects, and external services involved in ArchiSurance's daily fund trading operations, following ArchiMate® 3.2 standards for modeling business processes and applications.

Question: 5

Please read this scenario prior to answering the question

ArchiAir Catering Services (ACS) manages the catering services for ArchiAir, a leading airline. ACS is the sole catering supplier for all ArchiAir flights, and its services include full provisioning to the aircraft. Currently, ACS operates three central production facilities, supported by distribution hubs and local preflight production facilities. The central production facilities are responsible for producing standardized non-food materials (such as plates, cutlery, and boxes), non-perishable food products, and key ingredients required by the local production facilities. These materials are subsequently distributed to the distribution hubs, which also serve as warehouses for the local production facilities. Within the local production facilities, multiple production machines are utilized, each featuring dedicated workstations for chefs and quality inspectors. Most of the local production facilities employ fully automated assembly lines, including built-in packaging stations. The loaded service trolleys are then transported to the aircraft using small lorries.

In response to investor pressure for ArchiAir to reduce its carbon footprint, the CEO of ACS has announced a plan to address this environmental concern. Subsequently, the Ministry of Social Welfare and Health has enacted a law mandating a reduction in CO₂ emissions from all production facilities by the end of the year. Additionally, the airline's decision to raise ticket prices due to escalating fuel costs has led to a decrease in passenger numbers. This, in turn, impacts the volume of non-food materials required from ACS. An internal investigation has produced a report highlighting the potential benefits of centralizing production facilities and reducing the number of distribution centers. Such changes would result in lower CO₂ emissions while still effectively meeting all the requirements of ArchiAir.

In addition to evaluating its supply chain to reduce its carbon footprint, ArchiAir is taking proactive steps to achieve a net zero carbon footprint for its IT operations. The Chief Information Officer (CIO) has identified two crucial requirements to support this endeavor. The first requirement involves switching to renewable energy for ACS facilities, which are often located in remote areas where traditional fuels are the primary source of energy. To align with sustainability goals, ArchiAir aims to transition these facilities to renewable energy sources. By utilizing renewable energy, ArchiAir can significantly reduce its reliance on traditional fuels and contribute to a greener operation. The second requirement pertains to the scalability of ArchiAir's IT operations, taking into account the airline's susceptibility to seasonal changes in demand. The CIO has observed notable disparities between sites that have additional blade servers and can scale their capacity, and sites that solely rely on the two mainframes housed in central facilities. A comprehensive report has revealed that the blade servers have a negligible impact on resource waste, whereas the mainframes are notorious for their power inefficiency, particularly during periods of low demand.

Refer to the Scenario

Which of the following answers best describes the proposed transition from baseline to target, including details of motivation for changes? Note that there is no need to show the details of the target state.

A.

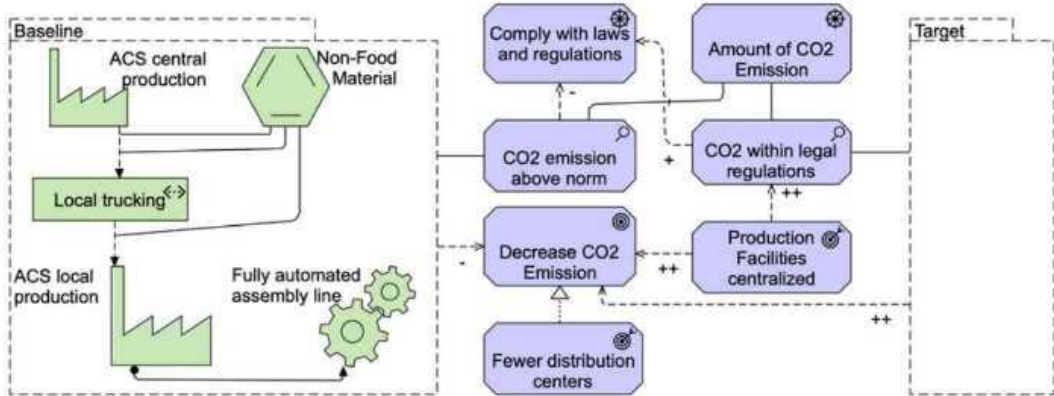

B.

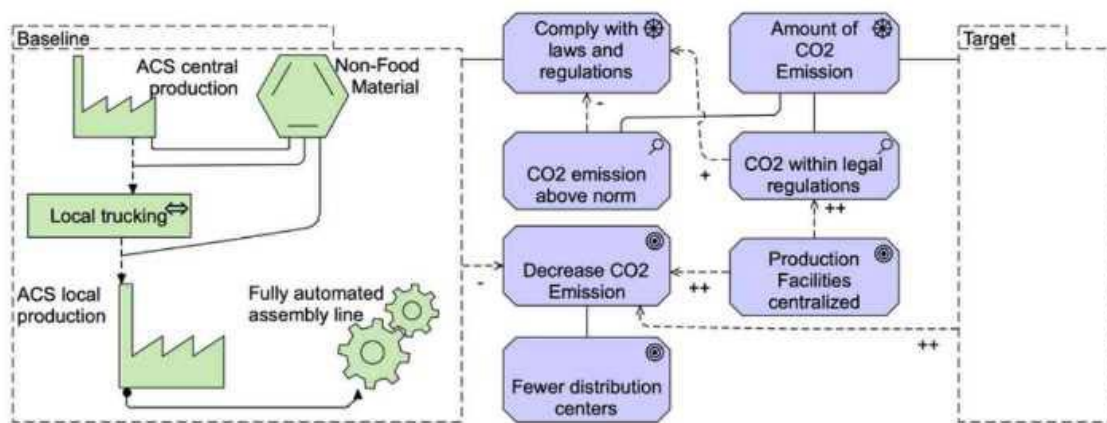

C.

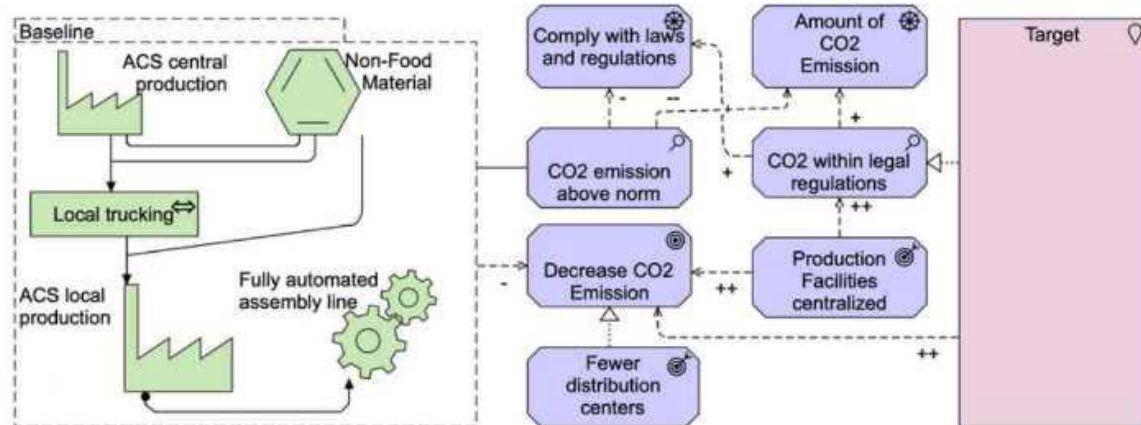

D.

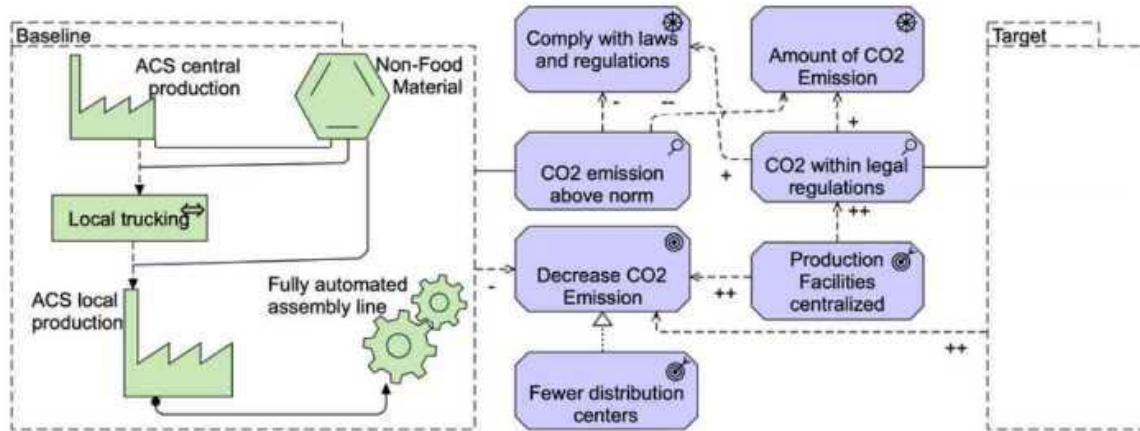

- A. Option A
- B. Option B
- C. Option C
- D. Option D
- E. Option E

Answer: D

Explanation:

The correct answer is D, as it best describes the transition from the baseline to the target state, including the motivation for changes based on the scenario. Here's a detailed explanation of why D is the most accurate model:

Baseline and Target:

The Baseline state in all answers correctly depicts the current structure of ACS's operations, including the ACS Central Production, Local Trucking, ACS Local Production, and Fully Automated Assembly Line. D captures the essential transition from this baseline state to the target state by illustrating how the organization is aiming to decrease CO2 emissions, as required by the new regulations, and how they intend to centralize production facilities.

Motivation for Changes (Decrease in CO2 Emissions):

The CEO's plan to reduce CO2 emissions is a critical driver for change. This is captured clearly in D, which shows the effects of Decreasing CO2 Emissions, Complying with Laws and Regulations, and Centralizing Production Facilities.

The Ministry of Social Welfare and Health's law mandating CO2 reductions is accurately reflected in D, showing compliance as part of the motivation.

D also depicts the motivation to centralize production facilities, which helps reduce CO2 emissions and aligns with the internal report suggesting that fewer distribution centers can meet ACS's needs effectively.

Business and Environmental Factors:

The scenario also points out that passenger numbers have decreased due to rising ticket prices, which reduces the demand for non-food materials from ACS. This factor is linked to the centralization effort, as reducing the need for distribution centers can reduce costs while still meeting business needs.

D reflects this by linking Fewer Distribution Centers and Centralized Production Facilities to both decreased emissions and operational efficiency.

Compliance with Laws and Regulations:

D shows a clear connection between compliance with CO2 Emission Laws and the Amount of CO2 Emissions generated by ACS, which is an essential driver of change in the scenario.

The need to ensure that emissions are within the legal limit is modeled effectively in D, reflecting the scenario's requirement to meet regulatory expectations by the end of the year.

Centralization of Production:

The scenario suggests that centralizing production is one way to reduce emissions and achieve operational efficiency. This is depicted clearly in D, where Production Facilities Centralized leads to both fewer distribution centers and a significant decrease in CO2 emissions.

D links the motivation for fewer distribution centers to environmental sustainability (CO2 reduction) as well as operational improvements.

Comprehensive ArchiMate® 3 Compliance:

D aligns well with ArchiMate® 3 standards. It models the Motivation Elements such as goals (e.g., Decrease CO2 Emissions), assessments (e.g., CO2 Emission Above Norm), and requirements (e.g., Comply with Laws and Regulations) accurately.

The relationships between these motivation elements are correctly depicted using ArchiMate® connectors like influences and associations, ensuring that the transition from baseline to target is clear and fully compliant with ArchiMate® 3 best practices.

Conclusion: Answer D provides the best representation of the proposed transition, focusing on the motivations for centralization and reduction of CO2 emissions. It accurately reflects the scenario's requirements, including legal compliance, environmental goals, and operational changes, all while following ArchiMate® 3 modeling standards.

Thank You for Trying Our Product
Special 16 USD Discount Coupon: NSZUBG3X
Email: support@examsempire.com

**Check our Customer Testimonials and ratings
available on every product page.**

Visit our website.

<https://examsempire.com/>